

## **FAQ:**

Software Issues:.....	3
1. Where can I download the soft wares and drivers for my printer P3000 Series?.....	3
2. Is my printer mac Compatible? What are the versions that it is compatible with?.....	5
3. Is my printer Linux compatible? What are the versions that it is compatible with?.....	5
Cartridge Issues:.....	6
4. How do I replace or insert a cartridge?.....	6
5. How do I check the amount of toner left in my cartridge?.....	6
6. How to check how many pages printed so far?.....	7
7. What are the cartridge models for my printer?.....	9
8. Why the Status Indicator shows orange when I insert a new cartridge?.....	9
Papers Jam issues:.....	9
9. How can I clear any paper jam?.....	9
10. Print jobs stuck in paper curve. What should I do?.....	14
11. What is my Printer Specifications?.....	14
12. What kinds of paper can I use in my printer?.....	15
Normal Printer Issue:.....	15
13. Why the printer could not feed paper successfully?.....	15
14. Why the printout is not clearly and a little whitish which one I just bought?.....	16
15. How to disassemble the additional tray?.....	16
16. How to adjust the sleep time setting?.....	19
17. Restore factory settings.....	20
18. How to set automatic duplex printing?.....	21
19. How to check the toner's serial number location:.....	24
20. How to check the printer's serial number location:.....	25

21. How to “add a printer “by manually.....	25
22. What is the power requirement will be need?.....	29
23. How to change the printing port is available when it showed” Printing port is on used” .....	29
24. Why it will be smoked when printing?.....	30
25. How to cancel a printing job in the queue?.....	31
26. How to adjust paper tray setting?.....	31
27. How to set printing method?.....	33

## Software Issues:

### 1. Where can I download the soft wares and drivers for my printer P3000 Series?

Here is the Link:

P3500DW:

<http://global.pantum.com/global/drive/p3500dw/>

P3500DN:

<http://global.pantum.com/global/drive/p3500dn/>

**Step1:** Please log in our website:

<http://global.pantum.com/global/>



**Step2:** Please chose “Drivers &Downloads”, the picture will be shown as below:

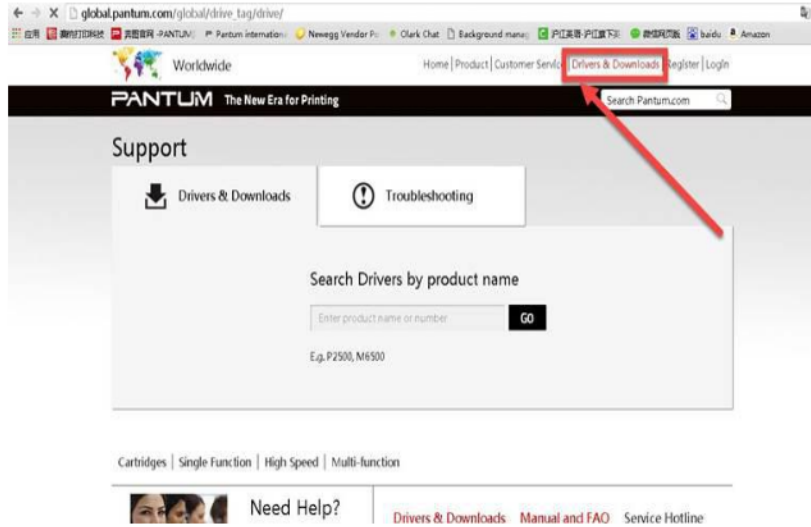

**Step3:** Please enter your model of your printer in the blank, the picture will be shown as below:

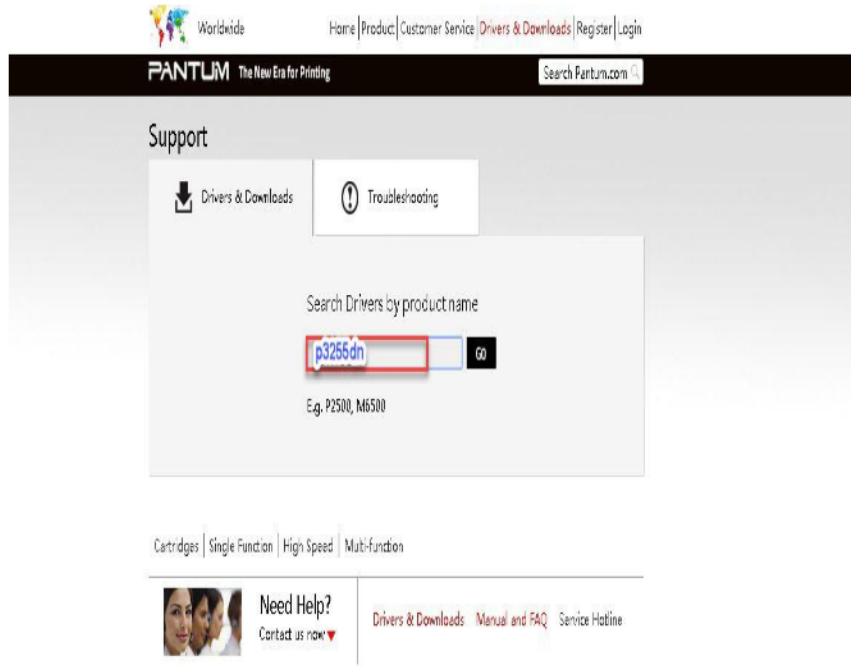



**Step4:** Please click the your model in the below picture:

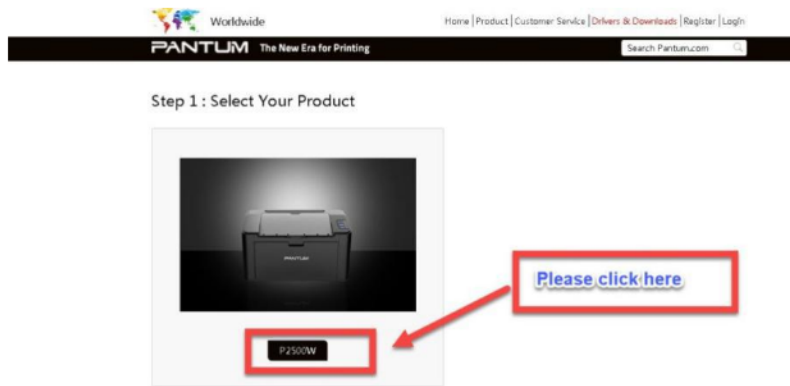

**Step5:** At last, please chose your system and “download “at the below of page, it will be done.



**2. Is my printer mac Compatible? What are the versions that it is compatible with?**

Yes, P3500 PCL6 series printer support Mac 10.4/10.5/10.6/10.7 /10.8/10.9/10.10/10.11.

**3. Is my printer Linux compatible? What are the versions that it is compatible with?**

Yes, Ubuntu 12.0.4/14.0.4.

## Cartridge Issues:

### 4. How do I replace or insert a cartridge?

Pull out the seal on the new toner cartridge firstly, and then insert the toner cartridge in the printer until hearing a “click” sound.

### 5. How do I check the amount of toner left in my cartridge?

**Step1:** Please click 'Prt Info Rept' in the menu setting.



**Step2:** Please chose NO.2 'Info Page' by page down.



**Step3:** At last, you will see it on the information Page.

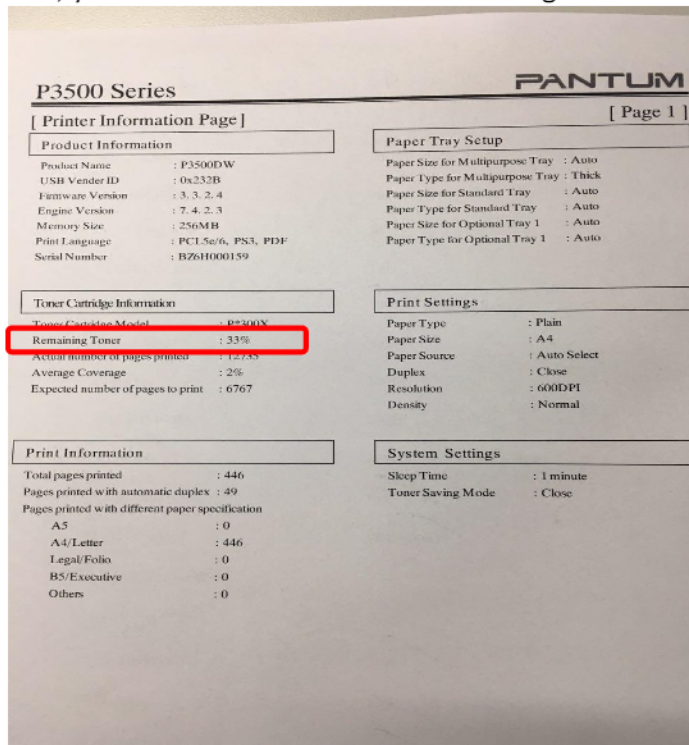

## 6. How to check how many pages printed so far?

**Step1:** Please click 'Prt Info Rept' in the menu setting.



**Step2:** Please choose NO.2 'Info Page' by page down.

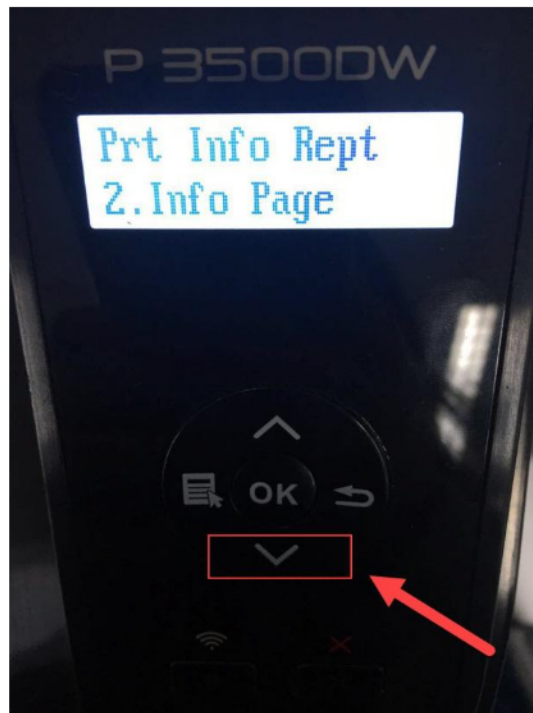

**Step3:** At last, you will see it on the information Page.

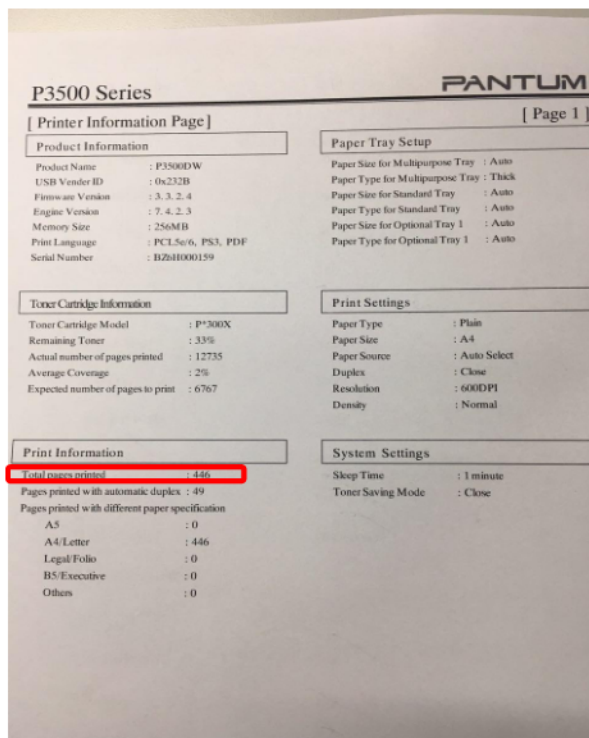

## 7. What are the cartridge models for my printer?

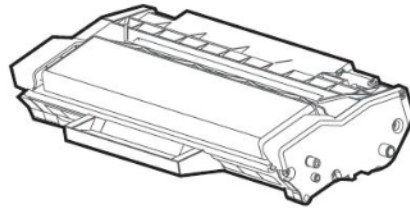

### Starter/Standard Cartridge:

Model: P\*-310 Page Yield: 3000 Pages

### High-Volume Cartridge:

Model: P\*-310H Page Yield: 6000 Pages

## 8. Why the Status Indicator shows orange when I insert a new cartridge?

**Step1:** Check the cartridge whether you pull out the seal on it

**Step2:** Take out of the chip from the cartridge and use a clean dry cloth to wipe it softly.  
Then install the chip;

**Step3:** Insert the toner cartridge in the printer until hearing a “click” sound.

## Papers Jam issues:

### 9. How can I clear any paper jam?

#### Paper jam in the Tray:

**Step1:** Open the tray.

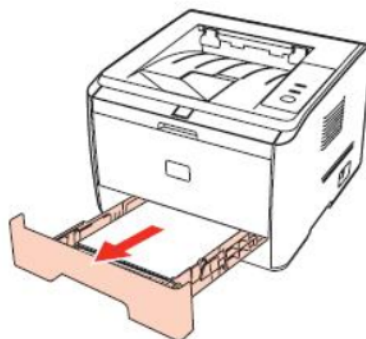

**Step2:** Gently pull the jammed paper straight out.



**Step3:** After removing the jammed paper, reload the tray into the printer, and restore the printing by pressing the button on the panel.

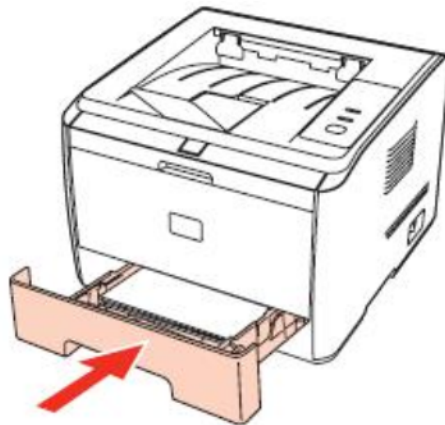

#### **Paper Jam in the Manual Feeder Tray:**

**Step1:** Gently pull the jammed paper out.

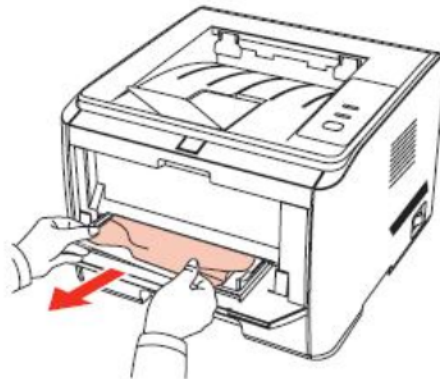

**Step2:** After reloading the paper into the tray, you can restore the printing by pressing the button on the panel.

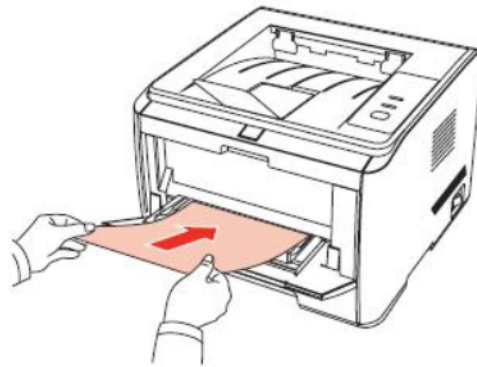

### Internal Jam:

**Step1:** Open the front cover.

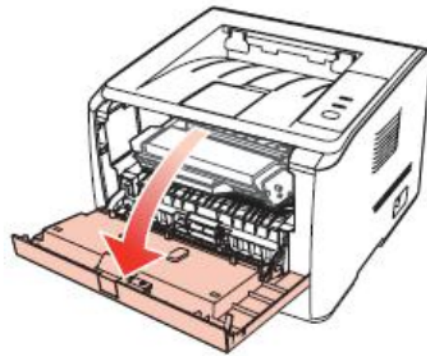

**Step2:** Remove the toner cartridge in a straight line. (To avoid the exposure of the toner cartridge which will affect the print quality, wrap the toner cartridge in a black plastic bag or cover it with paper.)

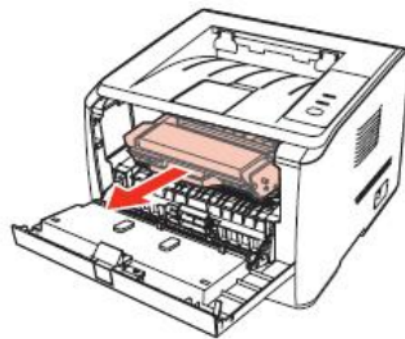



**Step3:** Gently pull the jammed paper straight out.

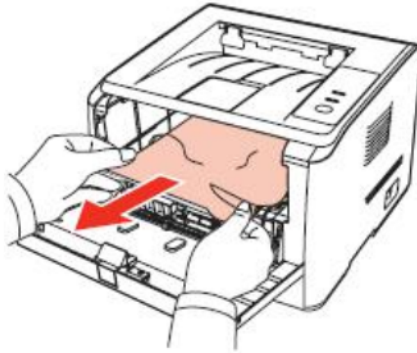

**Step4:** After removing the jammed paper, reload the toner cartridge and close the front cover, then the printer will automatically resume printing.

#### **Paper Jam in the Fuser Unit:**

**Step1:** Open the rear cover.

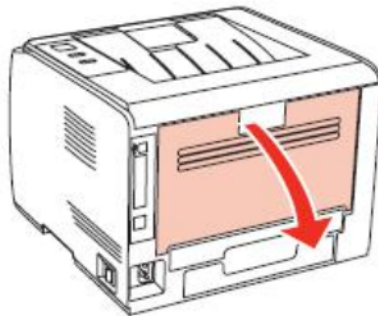

**Step2:** Open the fuser door using the handles on both sides.

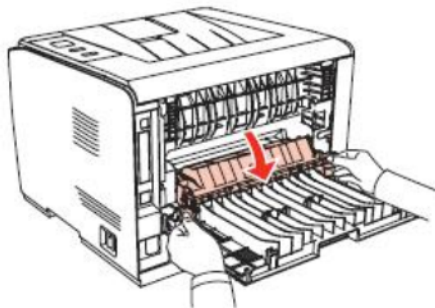



**Step3:** Gently pull the jammed paper straight out.

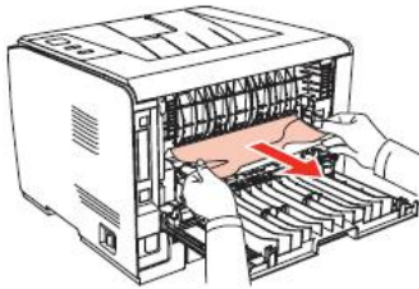

**Step4:** Remove the jammed paper and close the fuser door and the rear cover, then the printer will automatically resume printing.

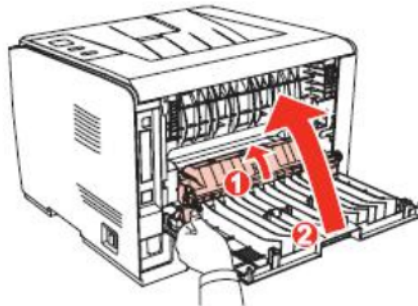

### Duplex Unit Jam:

**Step1:** Remove the duplex printing unit from the back of the printer.

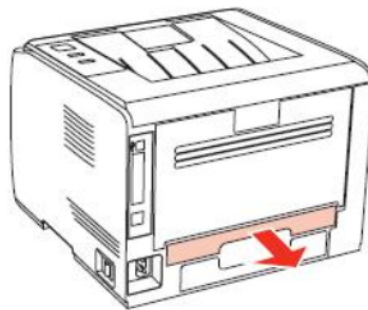

**Step2:** Remove the jammed paper from the duplex unit.

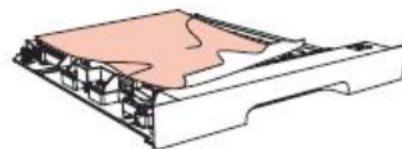

**Step3:** If the paper does not come out along with the duplex unit, open the tray and remove the jammed paper directly from the bottom.

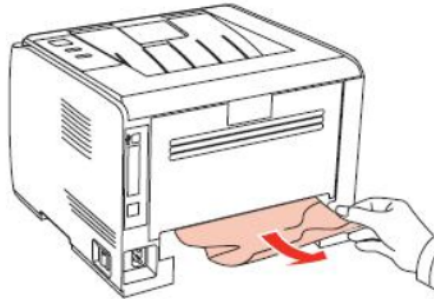

**Step4:** After clearing the jam, reload the duplex unit, check other parts of the printer, ensure that there is no jammed paper, and close the front cover, then the printer will automatically resume printing.

### 10. Print jobs stuck in paper curve. What should I do?

Fetch the papers from output bin, and keep the paper is just unpack from the package not be too wet or get static electricity, too avoid or decline paper curve .

### 11. What is my Printer Specifications?

Compatible Cartridges	
Cartridges Compatible	Starter cartridge: 3,000 pages included
Output Type	Monochrome
Black Print Speed	Up to 35 ppm
Black Print Quality	1200 x 1200 dpi
Duplex printing	yes
Max. Duty Cycle	Up to 50,000 pages monthly
Ports	
Network Ports	Ethernet 10/100/1000BaseTX (RJ-45)
Connectivity Technology	Wireless 802.11b/g/n
Hardware	
Processor(MHz)	600
Memory, std.	256 MB
Compatibility	
Windows Compatible	Microsoft Windows Server2003 /Server2008 / Server2012 /XP /Vista /Win7 /Win8 /Win8.1 /Win10(32/64 Bit)
Dimensions & Weight	
Dimensions	14.96" x 17.55" x 18.97"
Weight	26.23 lbs.

## 12. What kinds of paper can I use in my printer?

Standard Input Tray	Media type	Plain, thin paper
	Media size	Auto*, A4, A5 Short Edge, A5 Long Edge, A6, JIS B5, IS0 B5, B6, Letter, Legal, Executive, Folio, Oficio, Statement, 16K, Big 16K, 32K, Big 32K.
	Media weight	60~105 g/m <sup>2</sup>
	Maximum capacity of the tray	250 pages
Multipurpose Feeder	Media type	Plain paper, thick paper, thin paper, transparent film paper, carton paper, label paper, envelope paper
	Media size	Auto*, A4, A5 Short Edge, A5 Long Edge, A6, JIS B5, IS0 B5, B6, Letter, Legal, Executive, Folio, Oficio, Statement, 16K, Big 16K, 32K, Big 32K, No.10 Env., Monarch Env, DL Env, C5 Env, C6 Env, ZL, Japanese Postcard, Long Paper (Maximum 1.2m), Custom, Yougata4, Postcard, Younaga3, Nagaga3, Yougata2
	Media weight	60~200 g/m <sup>2</sup>
	Maximum capacity of the tray	60 pages
Optional Tray	Media type	Auto*, Plain, thin paper
	Media size	Auto*, A4, A5 Short Edge, JIS B5, IS0 B5, Letter, Legal, Executive, Folio, Oficio, Statement, 16K, Big 16K.
	Media weight	60~105 g/m <sup>2</sup>
	Maximum capacity of the tray	550 pages (single optional tray)
Output Tray Capacity		150 pages

## Normal Printer Issue:

### 13. Why the printer could not feed paper successfully?

There are three possible reasons as below:

- a. There is too much paper in the tray:  
Remove excess paper from the tray.
- b. The print media is loaded incorrectly:  
Please correctly load the print media.
- c. The print media is beyond the usage specification range.  
Please use the print media within the specification range.

#### 14. Why the printout is not clearly and a little whitish which one I just bought?

Take out the cartridge, hold the handle of the cartridge and gently shake around 5 to 6 times, so as to make the toner evenly distributed inside the cartridge.

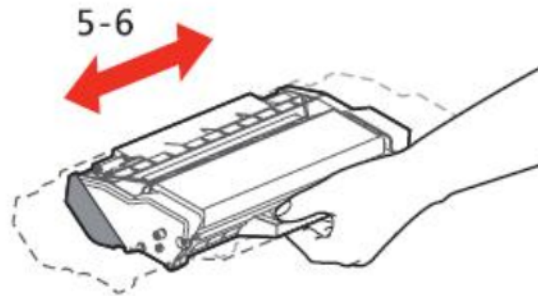

#### 15. How to disassemble the additional tray?

1) The method of disassemble

**Step1:** Take out paper tray (take it out completely)



**Step2:** Be gently separated the middle of paper tray and rear cover (from left side to right side)



**Step3:** Follow the above step 2 to separate the paper tray bottom same.

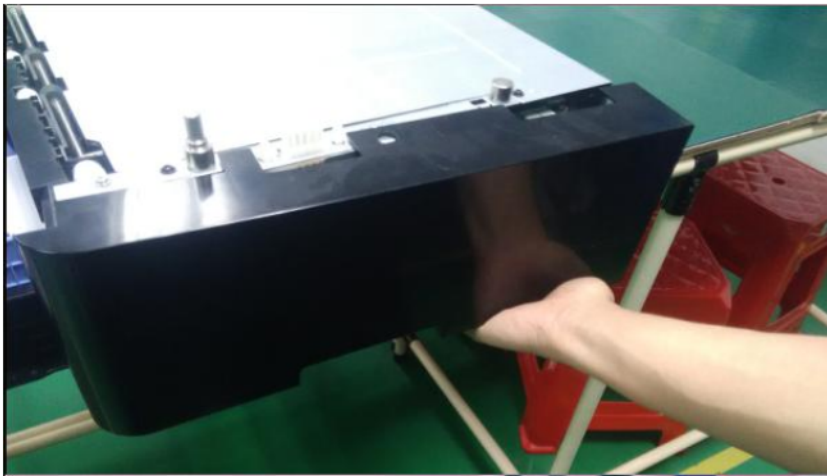

Take out the outer cover from right side to left side.

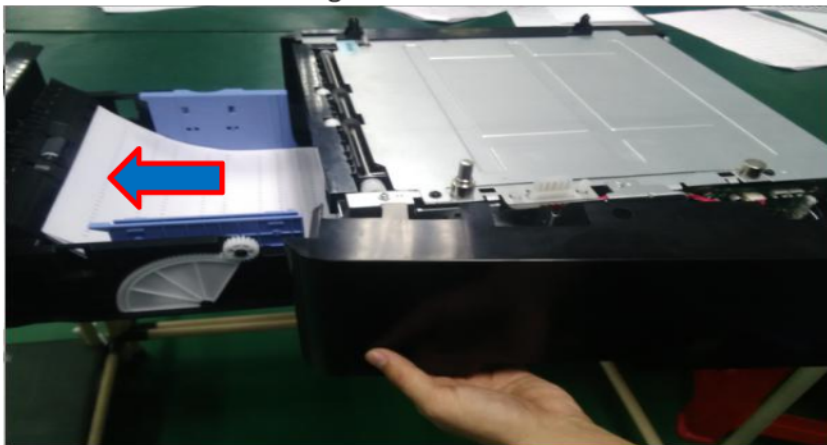

**Please take a note that don't touch paper size selector.**

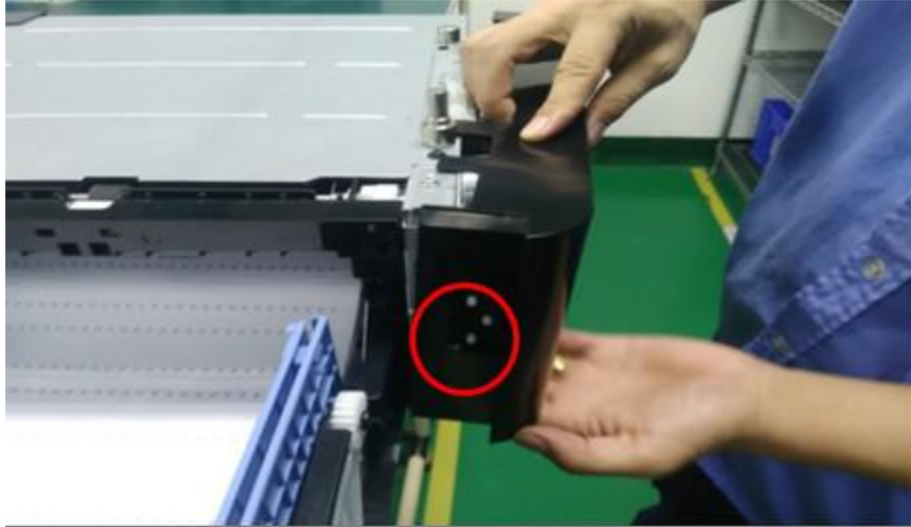

## 2) Verification methods

**Step1:** Overturn the paper tray shown as below:

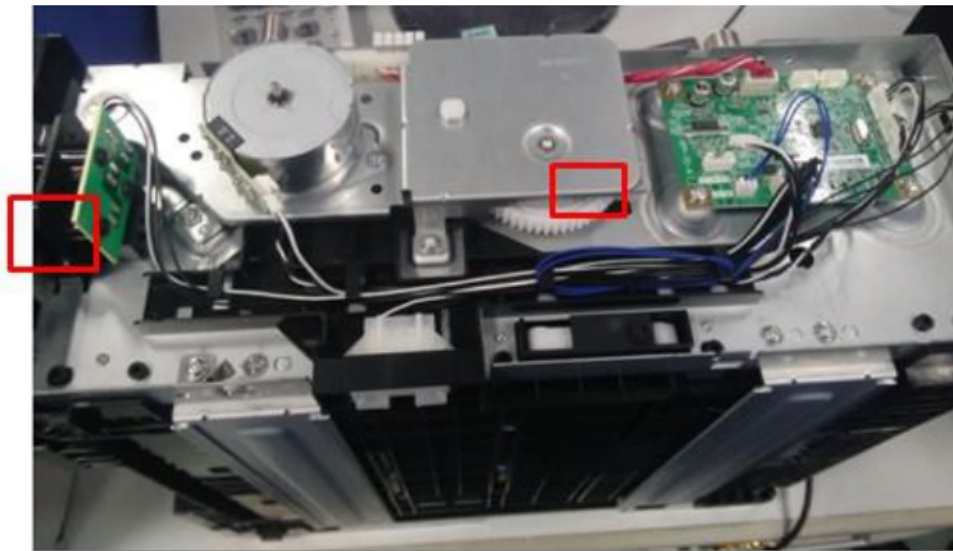

**Step2:** Confirm that plug wire into the appropriate side as shown above picture. If the status is NG, you can confirm it after starting printer. If the status is ok, but still have troubles with printer, it may cause by motor or board.

## 3) Installation methods

**Step1:** Install the paper size selector of outer paper tray first.





**Please take a note that don't touch paper size selector.**

**Step2:** Then install the other parts of paper tray .It will be finished.

## 16. How to adjust the sleep time setting?

**Step1:** please choose the NO2. Sleep time setting in the system setting by page down button.

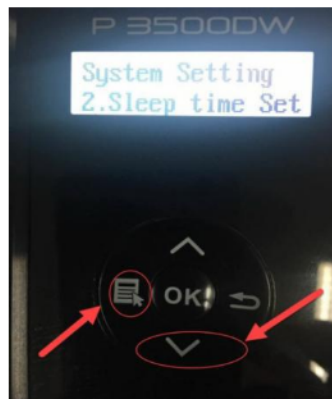

**Step2:** you can select from ' 1 min ' to '8 hours' in the sleep time set.



---

**Note:** When the printer is in dormant status, you can wake it up just by pressing any button or sending print task.

## 17. Restore factory settings

“Restore factory settings” is used to restore to printer default settings.

**Step1:** Press “Menu” key to enter menu setting interface.

**Step2:** Press "OK" key to select "1. System Settings".

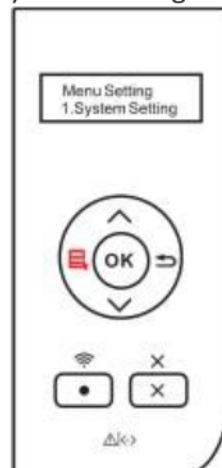

**Step3:** Press direction key “▲” or “▼”, select “4. Restore factory settings” and press “OK”.

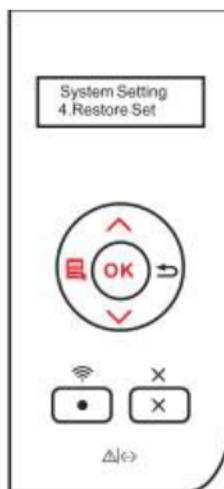



## 18. How to set automatic duplex printing”?

### 1) Automatic duplex printing with standard input tray

Before printing, please make sure a certain volume of medium has been loaded into the standard input tray.

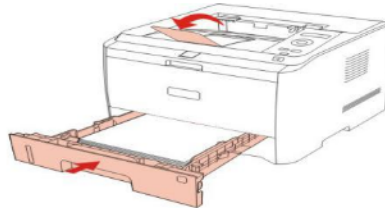

### 2) Automatic duplex printing with multifunctional input tray

Feed paper from multifunctional input tray for automatic duplex printing.

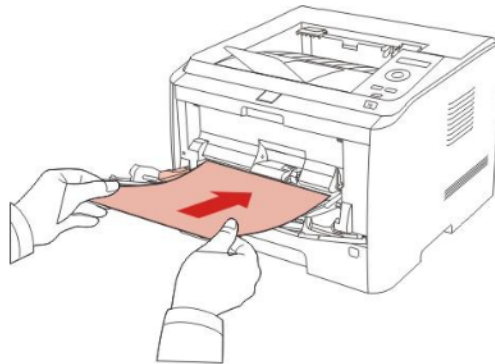

When you put paper into the multifunctional input tray, this printer will select the printing paper inside multifunctional input tray in priority.

Note: • The multifunctional input tray can realize automatic duplex printing, but it can hold 60 pages of paper at most. Besides, the recommended printing paper type should be used.

- The multifunctional input tray supports automatic duplex printing of common paper.

3) Automatic duplex printing with optional tray

Before printing, please make sure a certain volume of medium has been loaded into the optional tray, and no medium is inside the standard input tray or multifunctional input tray; or make sure the user set optional tray as the paper source.

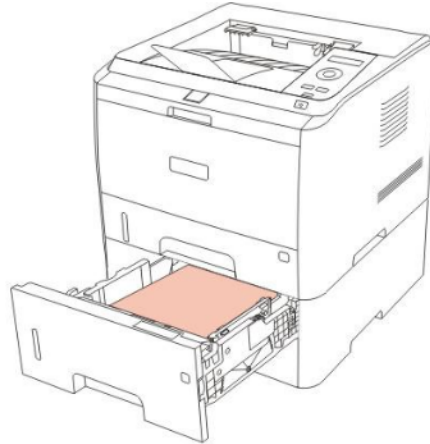

Note: The optional tray supports automatic duplex printing of common paper only. Do not put any special printing medium into the option tray.

The steps of automatic duplex printing are listed as below (this chapter applies to the windows system only)

**Step1:** Open the task to be printed from an application program (like notepad).

**Step2:** Select “printing” in “document” menu.

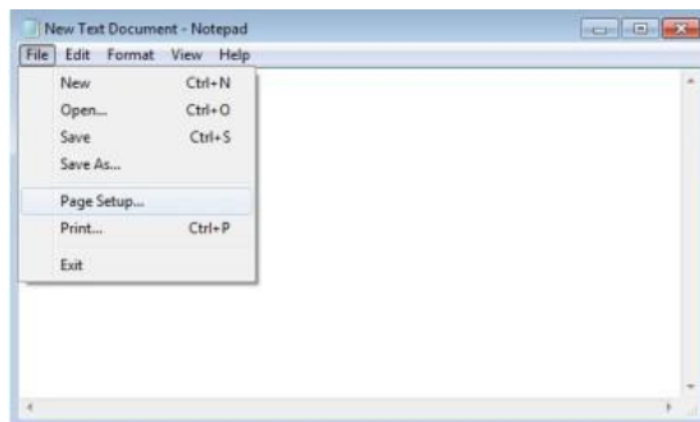

**Step3:** Select the printer according to the corresponding model shown in the figure.

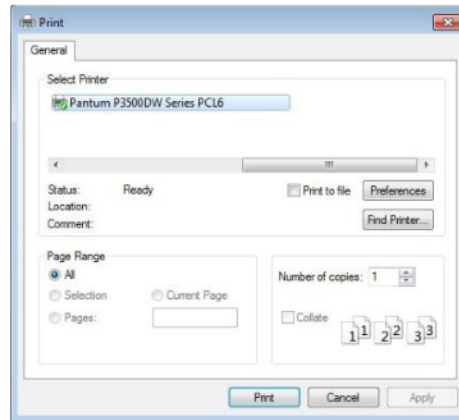

**Step4:** Click the “preference option” or “attribute” button, for printing configuration.

**Step5:** Select the “duplex printing” area under “basic” tab, with “long side” or “short side” binding style optional.

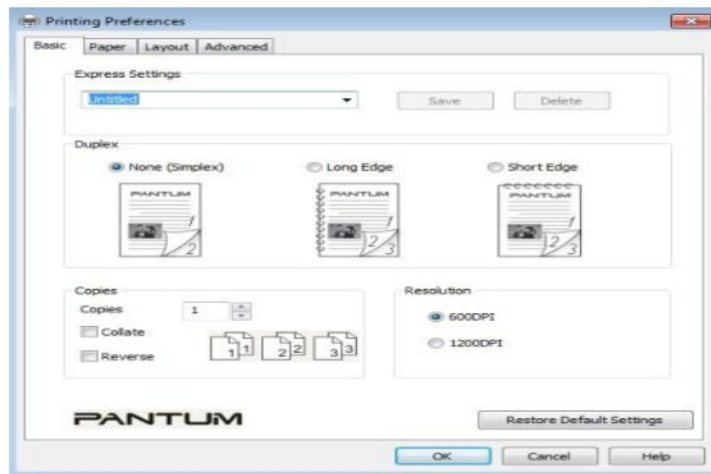

**Step6:** Click “OK” to complete printing settings, and then automatic duplex printing is realized.

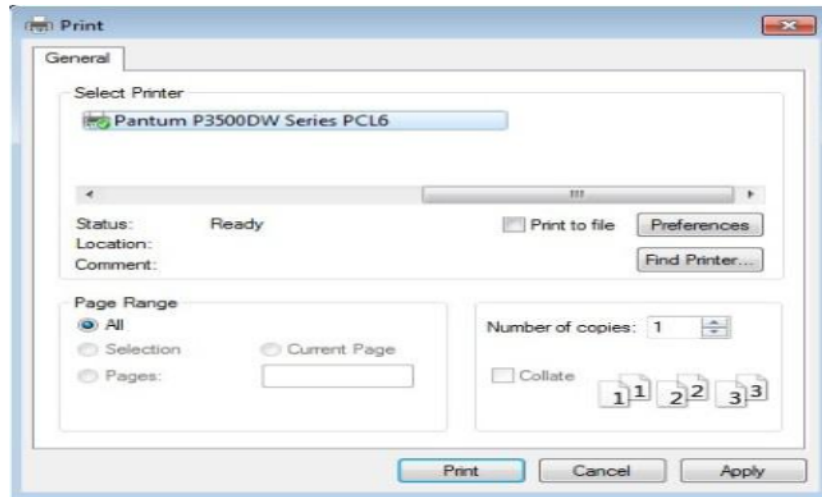

Note: • It is recommended to raise paper supporting board, preventing the printed paper from slipping from the paper tray. If you select not to raise the paper supporting board of output tray, we recommend you take away the printed paper immediately after it is output.

- During printing, the printer automatically adjusts the direction of text on the page.

## 19. How to check the toner's serial number location:

Please check with below pictures:



## 20. How to check the printer's serial number location:

Please check with below pictures:

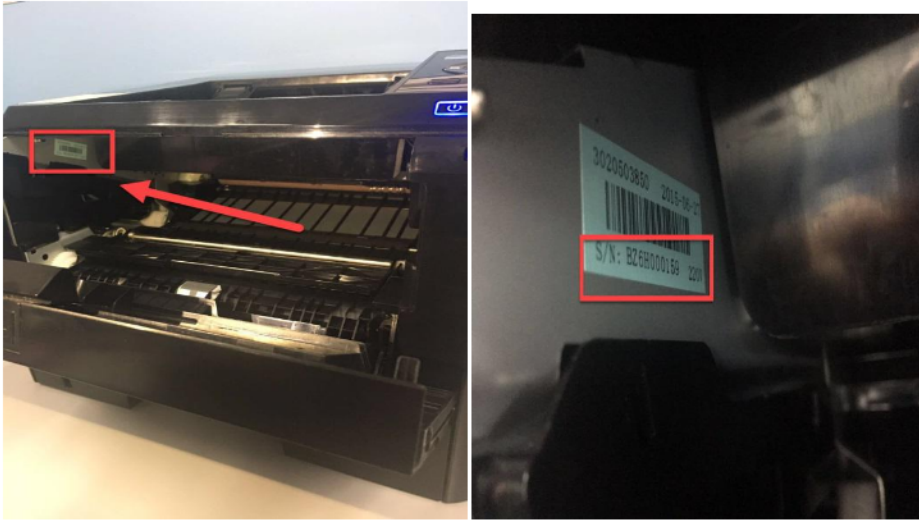

## 21. How to “add a printer “by manually

**Step1:** Click “add a printer”, it will be shown as below:

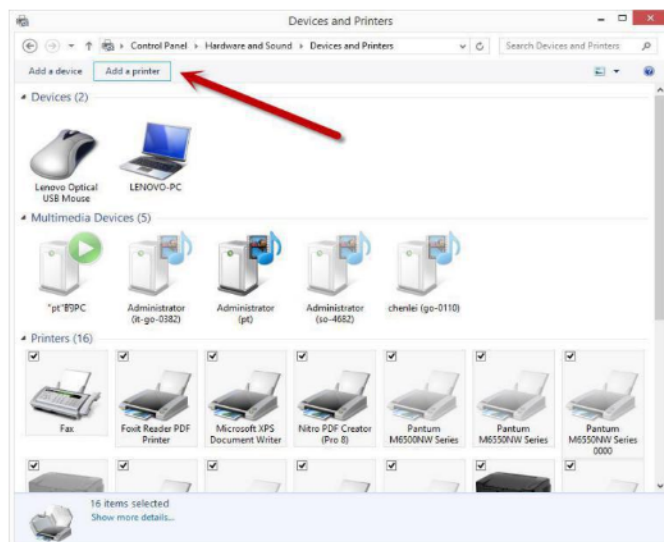

**Step2:** Please chose “the printer that I want isn’t listed” and chose ‘next” , it will be shown as below:

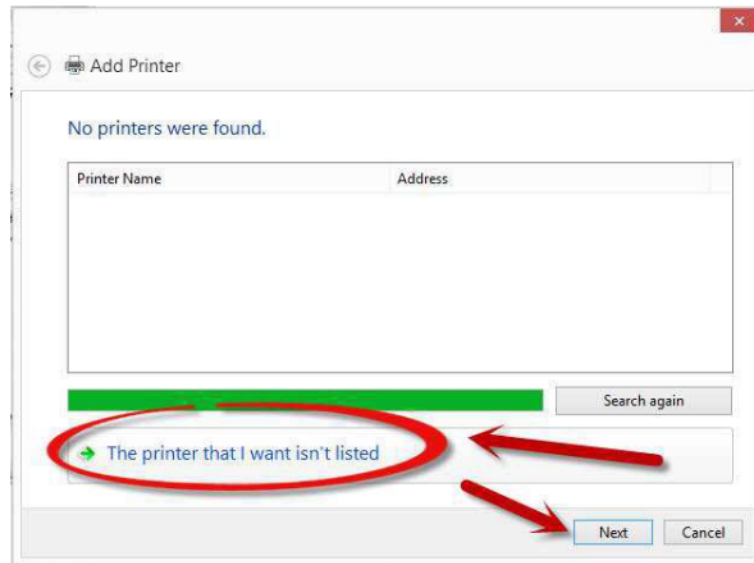

**Step3:** Please chose” adds a local printer or network printer with manual settings” and chose “Next”, it will be shown as below:

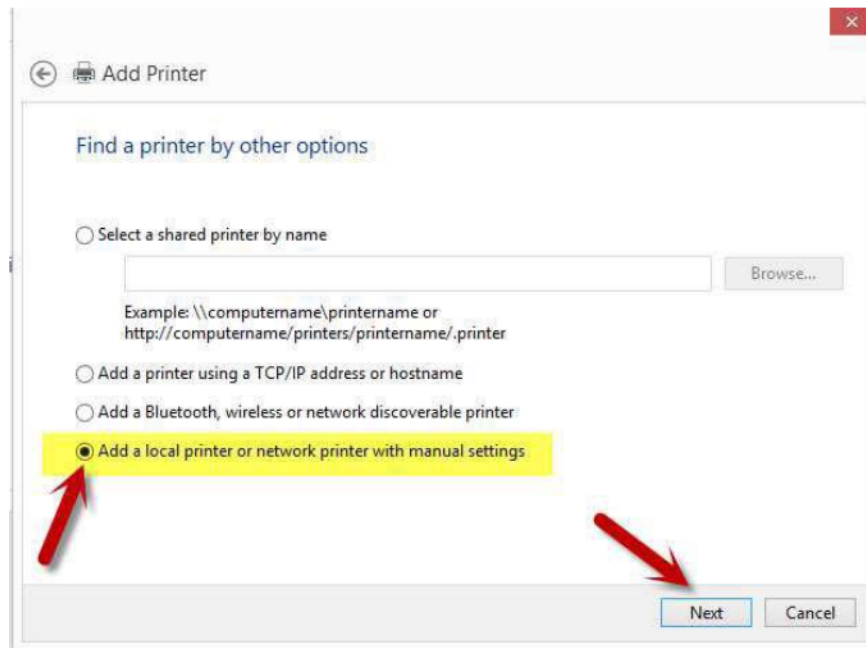

**Step4:** Please chose “Use an existing port” and select “Next”, it will be shown as below:

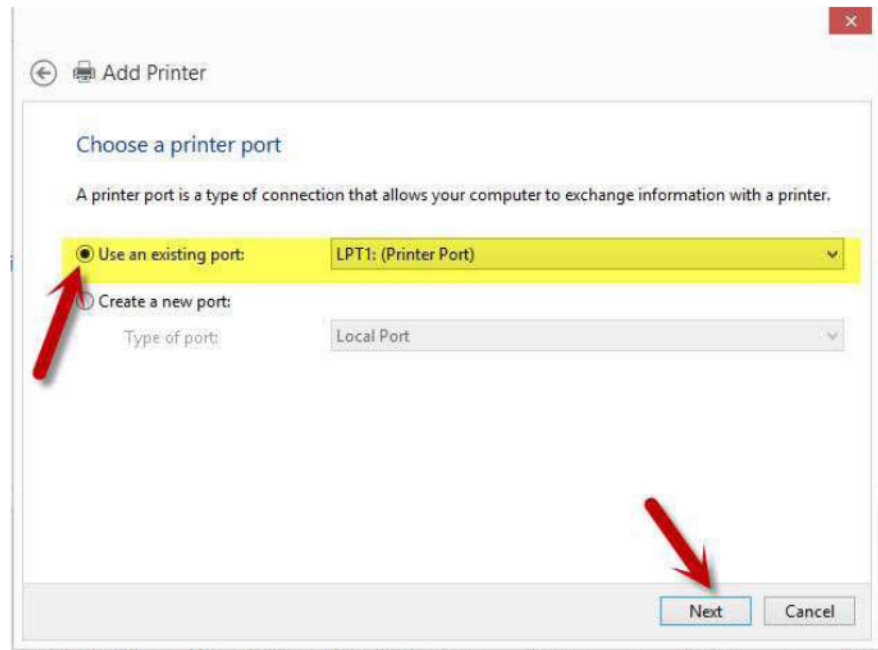

**Step5:** Please chose ‘have disked” and click “Next”, it will be shown as below:

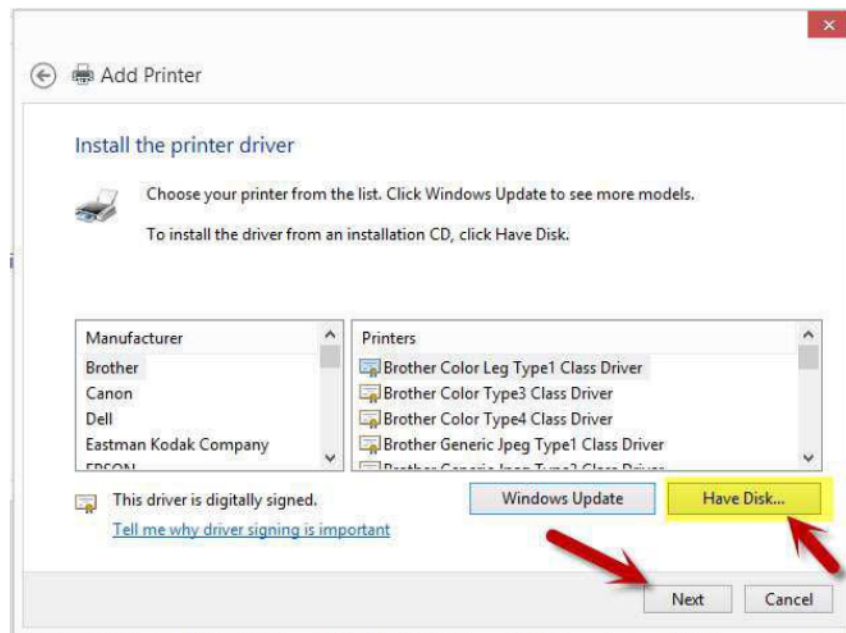

**Step6:** Please chose “browse” when the windows pop up, it will be shown as below:

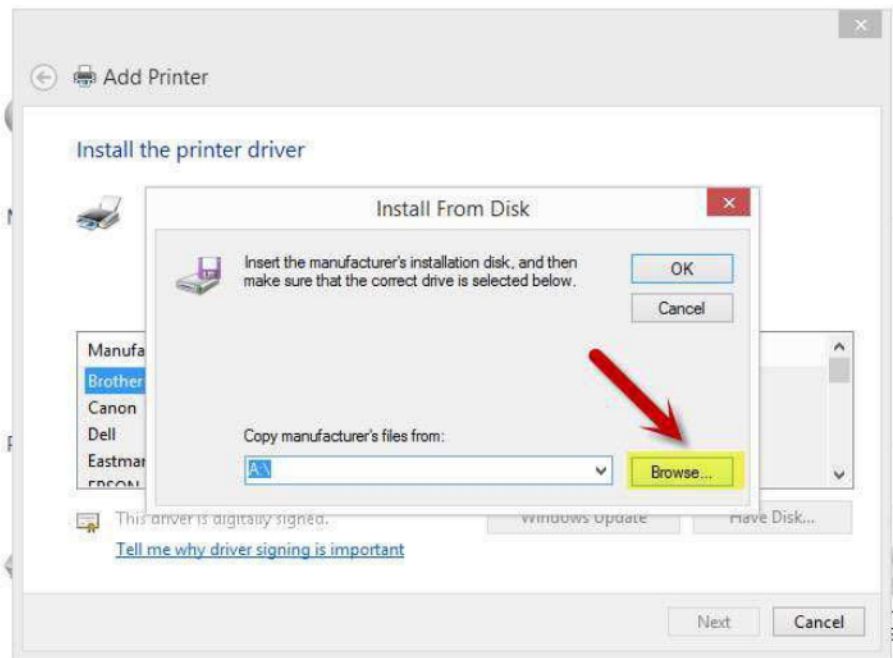

**Step7:** Please chose the “INF file” in the installation package and then chose “Next” it will be done.

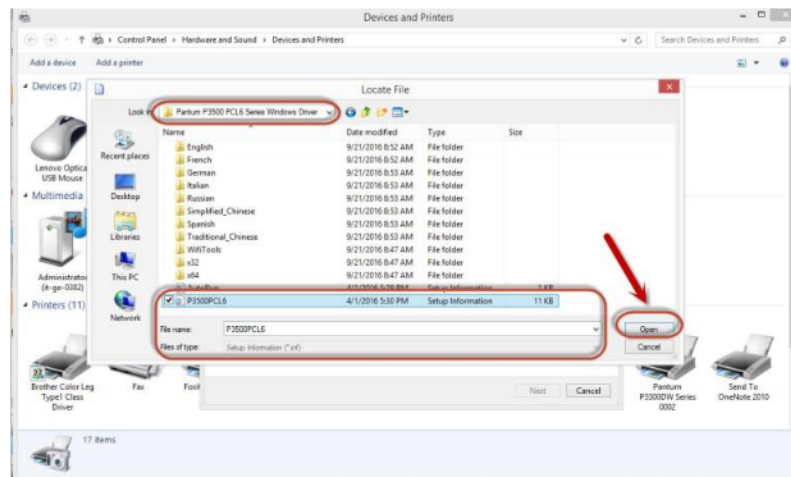

**Step8:** It will be finish to installation automatically after you pull up the printer’s USB cable.



## 22. What is the power requirement will be need?

Please check it with your power's specification behind your printer.

## 23. How to change the printing port is available when it showed" Printing port is on used".

"Printer cannot be configured because printing port is on used." it may cause by PC port is abnormal.

We suggest that you can check with below steps:

**Step1:** Change to another PC port then reconnects to the printer and re-install the driver.

**Step2:** Click PC table "start"->"Devices and Printers", delete the useless printer copy manually (the mouse right click on the useless printer name, and then delete it).

Then reconnect to the printer and re-install the driver.

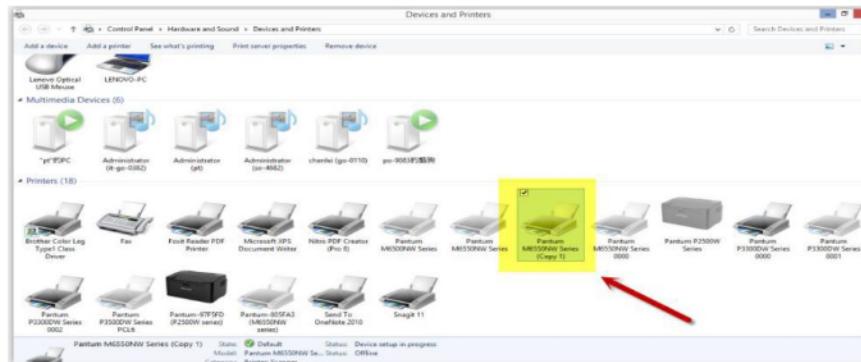

**Step3:** Click PC table "start"->"printer and fax", chose any of the printer copy, the mouse right click on the "printer property"->"port", then chose the customer no need the printer copy port of all the printers, and click "delete port"->"confirm". At last reconnect to the printer and reinstall the driver.

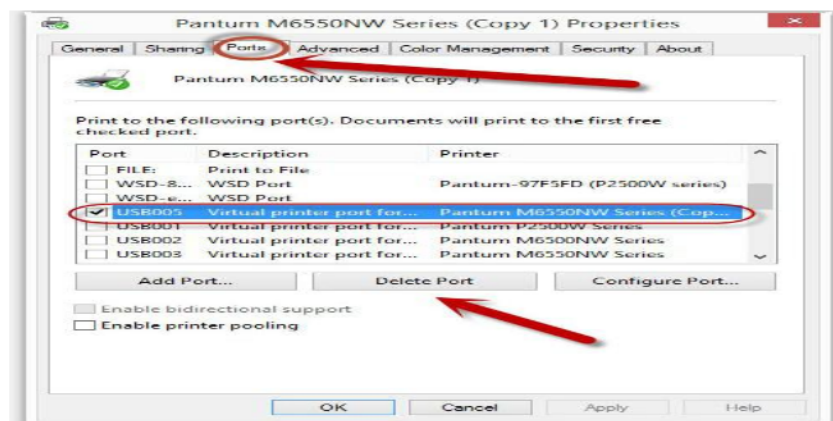

## 24. Why it will be smoked when printing?

The smoking is water vapor, which is caused by the printing environment and paper status. When we do the printing, the fuser unit will heat the paper to around 180 °C, so during paper out of the printer, it would exchange its temperature with surrounding environment.

1, Print environment: when the temperature becomes much lower, the humidity will be much higher, so the vapor will get heavy. Due to the temperature difference and moist, the water vapor will produce accordingly. Usually, we suggest the printing temperature is 10-32 °C, Humidity (RH) is 20%-80%, and it will work fine.

2, Paper status: the paper status when dry or moist will also influence strongly the printing vapor. When the paper is just unpacked to print, or just laid in the dry environment, there would be no or less vapor; But when the paper is very moist, for example, it was exposed in 90% RH environment for a day, when printing, there will be more vapor coming out.

So, that is the cause of printing vapor, we must take care of the printing environment and the paper to avoid it.

The other vendor's printers also meet the same issue because of the same mechanism. Here is the information for reference:

<http://h30434.www3.hp.com/t5/Inkjet-Printing/Smoke-when-printing/mp/5283314/highlight/true#M227548>



Posts: 2  
Member Since: 10-02-2015

Message 1 of 4  
(114 Views)  
[Report Inappropriate Content](#)

**Product Name:** HP Color LaserJet CP1217

when printing this printer has started to smoke from the slot where the printed paper emerges. I have turned the machine off and am anxious about using it. There is no smell of burning just very fine smoke. What is the problem? I got the machine second hand but it has worked well for two years until this week.

0  [Reply](#)

**✓ Re: Smoke when printing**  
10-02-2015 06:09 AM

If you do not smell smoke then it is possible you have paper in the printer that has too much moisture in it.

Paper can absorb moisture from the air if it is sitting in a humid environment out of its sealed ream. The absorption can happen fairly rapidly in a very humid environment and over time in even a slightly humid environment.

Since there is no smell it is likely water vapor, I would recommend you go and purchase a fresh ream of paper and try printing and see if the vapor is gone.

The printer has thermal protection in the future to prevent overheating, and it cannot run hot enough to set paper on fire. The fuser does run hot enough to vaporize water.

If my post provides an answer to your question please mark it as a solution. Whenever any Technician posts helpful answer to your question you can thank them by giving them kudos, just click the thumbs up button under the post.

 [View solution in context](#)

Everyone's Tags: [HP Color LaserJet CP121...](#) [View All \(1\)](#)

## 25. How to cancel a printing job in the queue?

Regarding the issue about your printer, please kindly check with below steps, you need to end the printing job in the printing queue:

**Step1:** Please double click your model of your printer in the 'printer and device", the picture will be shown as below:

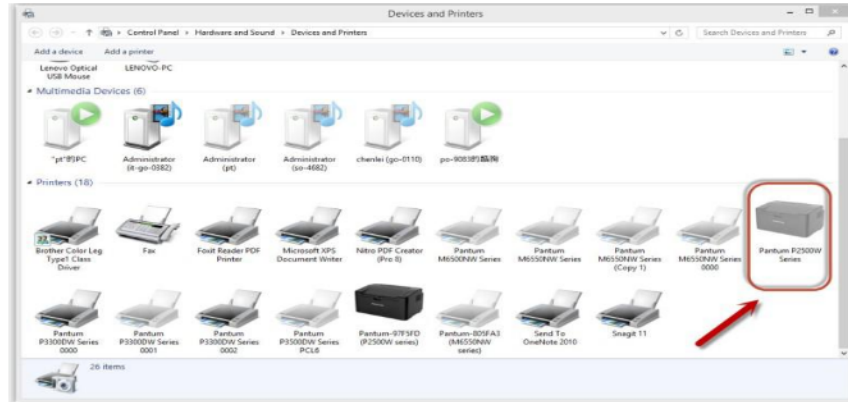

**Step2:** Please right click the printing task that you want to stop. It will be shown as below:

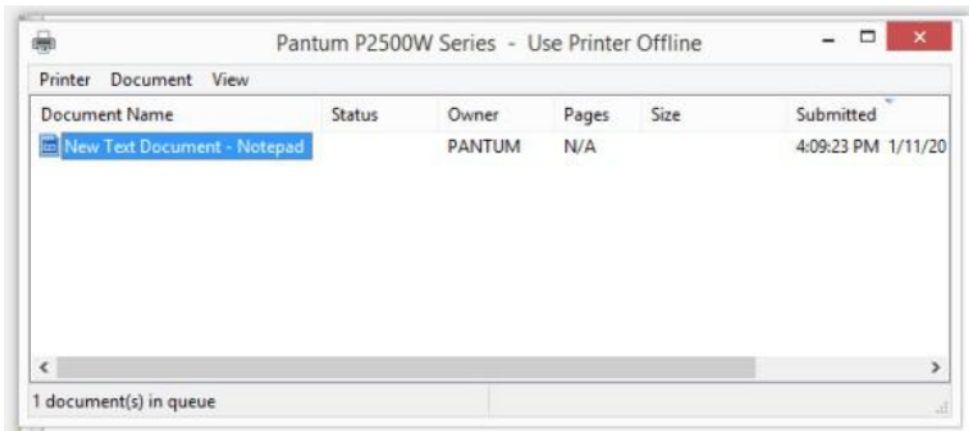

**Step3:** Please chose "cancel", it will stop printing job.

## 26. How to adjust paper tray setting?

1) Paper tray setting on dial

Both standard input tray and optional tray of a printer are equipped with a paper size displaying dial. Taking "standard tray" for example, settings of paper size displaying dial are described as follows:

Size supported by dial *	B5, STA, LGL, LTR , A4, A5
--------------------------	----------------------------

**Step1:** Pull the standard input tray out of printer.

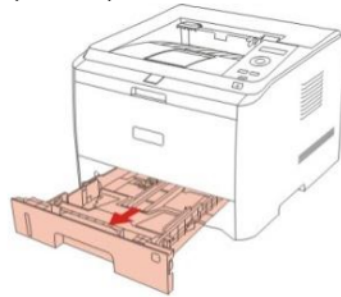

**Step2:** Turn the paper matrix dial to matching to the paper size inside paper tray.

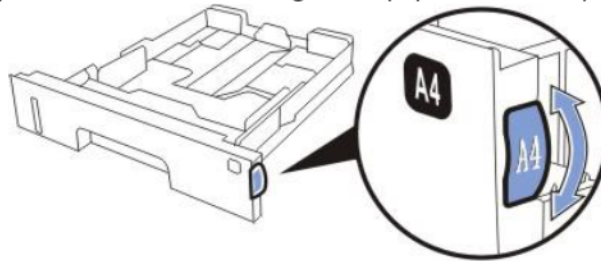

**Step3:** Install the paper tray into the printer.

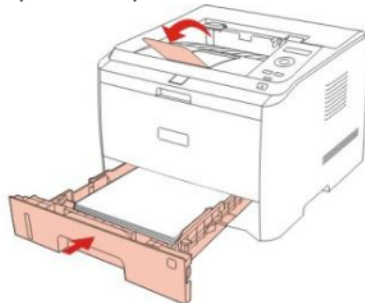

Note: • when a paper size to be set cannot be found on the dial, the user can set it on the control panel of printer. Please refer to Chapter 7.

## 2) Paper tray setting on control panel

Note: The paper size settings of standard tray, multi-function tray, and optional tray can be done on control panel. Here, we take the setting of standard tray for example.

Press the “menu” button to enter into the menu setting interface.

**Step1:** Press the direction key “▲” or “▼” to select “2. Paper tray settings” option. Press “OK” button.

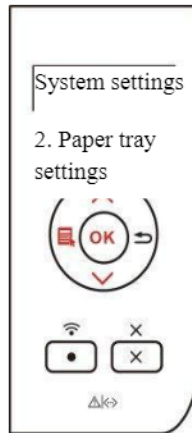

**Step2:** Press the direction key “▲” or “▼” to select “2. Standard tray” option. Press “OK” button.

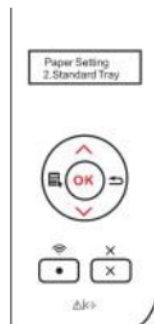

**Step3:** Press the direction key “▲” or “▼” to select “2. Paper sheet size” option. Start setting.

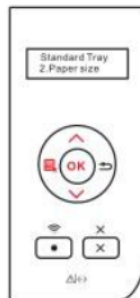

## 27. How to set printing method?

- 1) Printing with standard input tray

Before printing, please make sure a certain volume of medium has been loaded into the standard input tray.

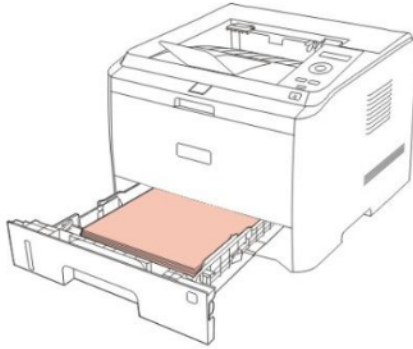

---

Note: • For paper feeding related precautions, please refer to Chapter 2.

- For the medium type related to printing of standard input tray, please refer to Chapter
- If the multifunctional input tray holds medium, please select “standard input tray” as the paper source through the menu key “2. Printing settings”, to ensure the normal printing of printer with paper fed from standard input tray.

---

#### 1) Printing with multifunctional input tray

When you put paper into the multifunctional input tray, this printer will automatically conduct printing with paper feeding from multifunctional input tray.

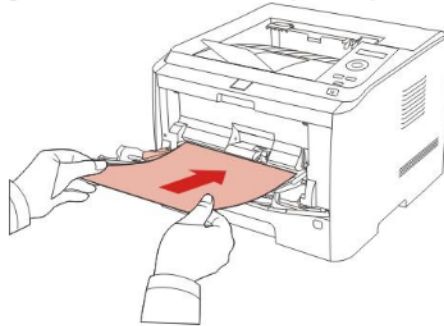

Note: The multifunctional input tray can be used for printing of special paper such as envelope and transparent film. It can once hold 60 pieces of paper, as a maximum.

## 2) Printing with optional tray

### Step1: Installation of optional tray

- a) Please make sure that both printer and optional tray are properly placed, as shown below.

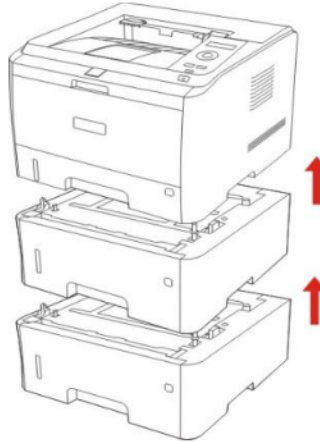

- b) Insert the power line into the printer, and turn on the power.

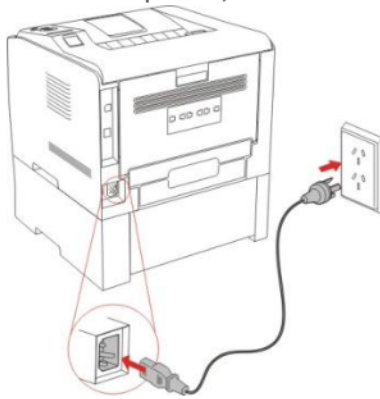

Note: • Before installation or moving of the optional tray, please cut off the power supply to the printer.

- After installation of optional tray, do not raise the printer during printing. Otherwise, the optional tray communication fails. The user need restart the printer for recovery

- c) On the equipment and printer interface of operating system, open the “printer attribute”; click the “auxiliary setting”; select “installed” under “installable options” to finish the installation of optional tray, as shown below.

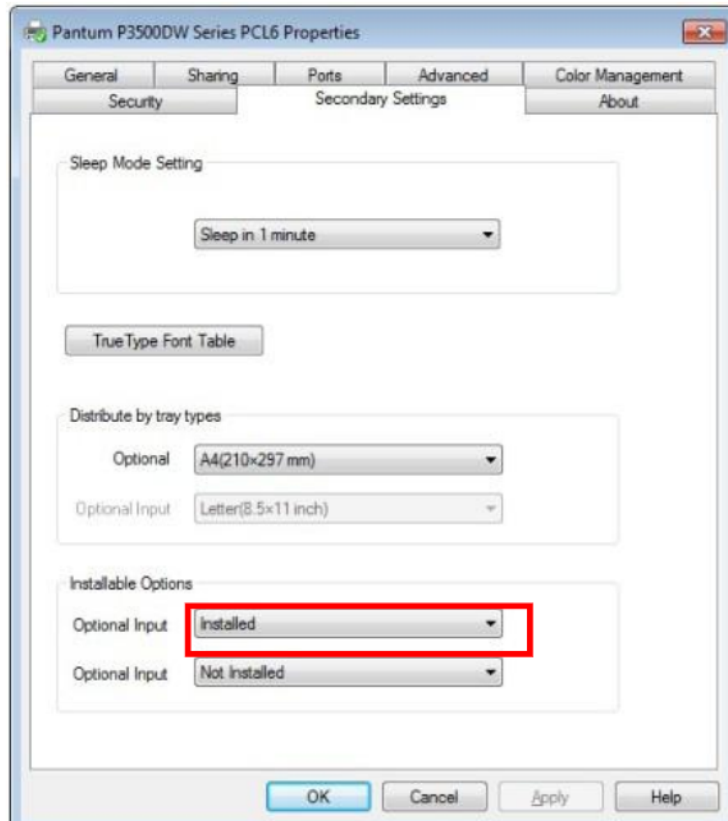

- d) When the multifunctional input tray and standard tray hold no paper, or when the user set “optional tray I/II” as the paper source, the printer will finish printing task with paper fed from optional tray.

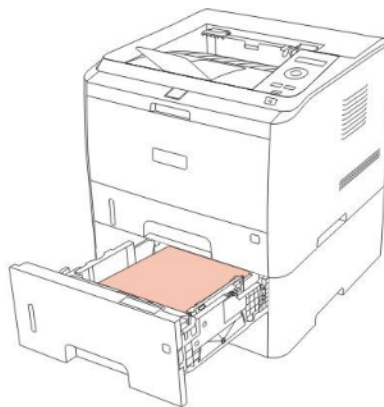

- Note:
- The optional tray can hold 550 pages of 80 g/m<sup>2</sup> common paper, as a maximum.
  - Please make sure that both optional tray and printer are normally installed.